

Portable GFCI Devices

Outdoor Rated Rainproof Devices
Provide Superior Personnel Protection



Leviton's Portable GFCI Devices are now sleeker and more rugged than ever! And, while these devices are fully OSHA compliant for use on job sites, they are also perfect for use in a variety of temporary power applications, such as recreation vehicles, portable pools, portable generators, submersible pumps, vending machines and more.



Features:

- Rainproof, Outdoor rated GFCI Module
- Fully complies with NEC and OSHA regulations for construction sites
- Automatic reset models automatically restore power to connected equipment when plugged in or after power interruption and are perfect for use in hard to access locations
- Manual reset models require manual actuation to restore power to the connected equipment and provide an extra level of safety
- Power Indicator lamp goes OFF if GFCI trips, power is interrupted or GFCI is unplugged
- Open-Neutral Protection immediately trips the GFCI if the neutral conductor on the line side is opened, eliminating the possibility of the load side of the GFCI having a live hot leg
- Cord Set models available in a variety of cord lengths with custom lengths and configurations available as special order
- For easy identification, the GFCI housings for automatic reset devices are black, and manual reset devices are yellow
- UL listed; complies with UL Standard 943 as a Class A GFCI power supply
- CSA Certified

Features

Cord Sets

- Equipped with Industrial Grade plugs and connectors to provide long service life in heavy-duty applications
- Polycarbonate, ultrasonically welded body provides long service life and excellent resistance to harsh weather
- RTV injected at cord entrance and exit of the housing better protects against moisture intrusion
- Power Indicator light goes OFF if GFCI trips, power is interrupted or line cord is unplugged
- Weather resistant SJTW cable



Manual Reset
GFCI Cord Sets

Automatic Reset
GFCI Cord Sets

User-Attachable Devices

- Polycarbonate, ultrasonically welded body provides long service life and excellent resistance to harsh weather
- Terminal chamber sealed with silicon and foam rubber gaskets for superior protection against moisture
- Accepts 12/3 AWG through 18/3 AWG types SJ and ST cords



Manual Reset
User-Attachable Device

Automatic Reset
User-Attachable Device

Specifications

AC Horsepower Rating		
At Rated Voltage	¾ Horsepower	
Electrical Specifications		
Amperage	15A or 20A as specified	
Voltage	120V AC	
Short Circuit Current Rating (SCCR)	2kA	
Trip Level	5 +/- 1 mA	
Environmental Specifications		
Flammability	Rated V-2 per UL 94	
Operating Temperature	-35°C to 66°C	
Material Specifications		
Cord Type	Cord Sets	SJTW
	User-Attachable	Accepts SJ & ST Cord Types
Body Material	Polycarbonate	
Blades/Contacts	Brass	

Mechanical Specifications	
Terminal ID (User-Attachable Devices Only)	Brass- Hot, Green- Ground, Silver- Neutral
Product ID	Ratings marked on device
Standards & Certifications	
NEMA	WD-6
ANSI	C73
UL Standard	943 Class A & 498
CSA	C22.2 No 42 & No 144
NOM	057
Warranties	
Warranty	2 Year Limited

Dimensions

Cat Nos
GFA15/GFM15
& GFA20/GFM20

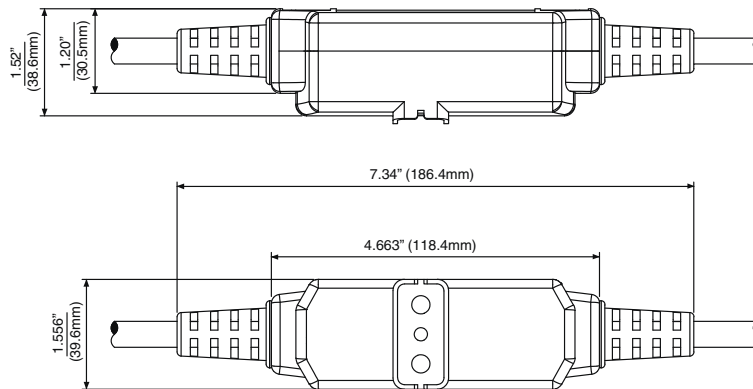



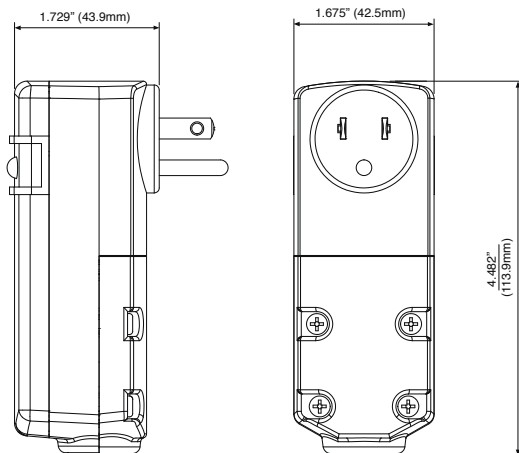



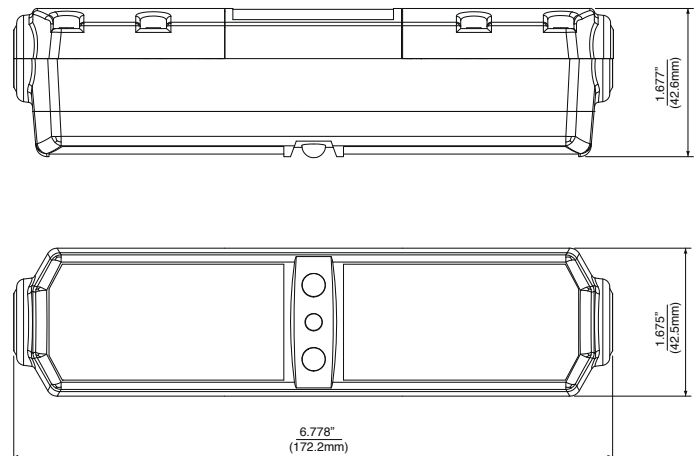











Cat Nos 16693/16694 & 16793/16794



Cat Nos GCA20/GCM20



Ordering Information

CATALOG NUMBER	DESCRIPTION	NEMA PLUG	NEMA CONNECTOR
GFCI Cord Sets - Automatic Reset			
GFA15-2C	2 ft. Cord Set, Molded-On Plug and Connector, Straight Blade, 14/3 SJTW Cord	5-15P 	5-15R 
GFA15-3TC	3 ft. Cord Set, Molded-On Plug and Triple Tap Connector, Straight Blade, 14/3 SJTW Cord		
GFA15-6C	6 ft. Cord Set, Molded-On Plug and Connector, Straight Blade, 14/3 SJTW Cord		
GFA15-25C	25 ft. Cord Set, Molded-On Plug and Connector, Straight Blade, 14/3 SJTW Cord		
GFA15-37E	37 ft. Cord Set, Molded-On Plug and No Connector , Straight Blade, 14/3 SJTW Cord	5-15P 	—
GFA15-100	100 ft. Cord Set, Molded-On Plug and Connector, Straight Blade, 14/3 SJTW Cord	5-15P 	5-15R 
GFA20-3C	3 ft. Cord Set, Molded-On Plug and Connector, Straight Blade, 12/3 SJTW Cord	5-20P 	5-20R 
GFA20-3LC	3 ft. Cord Set, Black & White® Locking Plug and Locking Connector, 12/3 SJTW Cord	L5-20P 	L5-20R 
GFA20-37E	37 ft. Cord Set, Molded-On Plug and No Connector , Straight Blade, 12/3 SJTW Cord	5-20P 	—
GFCI Cord Sets - Manual Resets			
GFM15-3C	3 ft. Heavy Duty Cord Set, Black & White® Plug and Connector, Straight Blade, 12/3 SJTW Cord	5-15P 	5-15R 
GFM15-3TC	3 ft. Heavy Duty Cord Set, Black & White® Plug and Triple Tap Connector, Straight Blade, 12/3 SJTW Cord		
GFM15-3WC	3 ft. Heavy Duty Cord Set, Wetguard® Plug and Connector, Straight Blade, 12/3 SJTW Cord		
GFM15-25C	25 ft. Cord Set, Black & White® Plug and Connector, 14/3 SJTW Cord	5-20P 	5-20R 
GFM20-3C	3 ft. Cord Set, Black & White® Plug and Connector, Straight Blade, 12/3 SJTW Cord		
GFM20-3WC	3 ft. Cord Set, Wetguard® Plug and Connector, Straight Blade, 12/3 SJTW Cord		
User-Attachable Devices - Automatic Reset			
16693*	Right-Angle GFCI Plug, Grounded	5-15P 	—
16693-1*	Right-Angle GFCI Plug, Grounded, BULK		
16793*	Right-Angle GFCI Plug, Grounded	5-20P 	—
16793-1*	Right-Angle GFCI Plug, Grounded, BULK		
GCA20*	In-Line GFCI Plug, Grounded	—	—
User-Attachable Devices - Manual Reset			
16694*	Right-Angle GFCI Plug, Grounded	5-15P 	—
16694-1*	Right-Angle GFCI Plug, Grounded, BULK		
16794*	Right-Angle GFCI Plug, Grounded	5-20P 	—
16794-1*	Right-Angle GFCI Plug, Grounded, BULK		
GCM20*	In-Line GFCI Plug, Grounded	—	—

* See instruction sheet for precise cord type/wire gauge applications.

Leviton Manufacturing Co., Inc.

201 North Service Road, Melville, NY 11747

Telephone: 1-800-323-8920 • Fax: 1-800-832-9538 • Tech Line (8:30AM-7:00PM E.S.T. Monday-Friday): 1-800-824-3005

Leviton Manufacturing of Canada, Ltd.

165 Hymus Blvd, Pointe-Claire, QC H9R 1E9

Telephone: 1-800-469-7890 • Fax: 1-800-563-1853

Leviton S. de R.L. de C.V.

Lago Tana 43, Col. Huichapan, Miguel Hidalgo, CP 11290 México DF

Telephone: (+52) 55-5082-1040 • Fax: (+52) 55-5386-1797 • www.leviton.com.mx

Visit our Website at: www.leviton.com/industrial email: industrial@leviton.com

© 2016 Leviton Manufacturing Co., Inc. All rights reserved.

